

Accurate solder paste inspection with unprecedented simplicity

Mycronic inspection solutions PI™ series 3D SPI

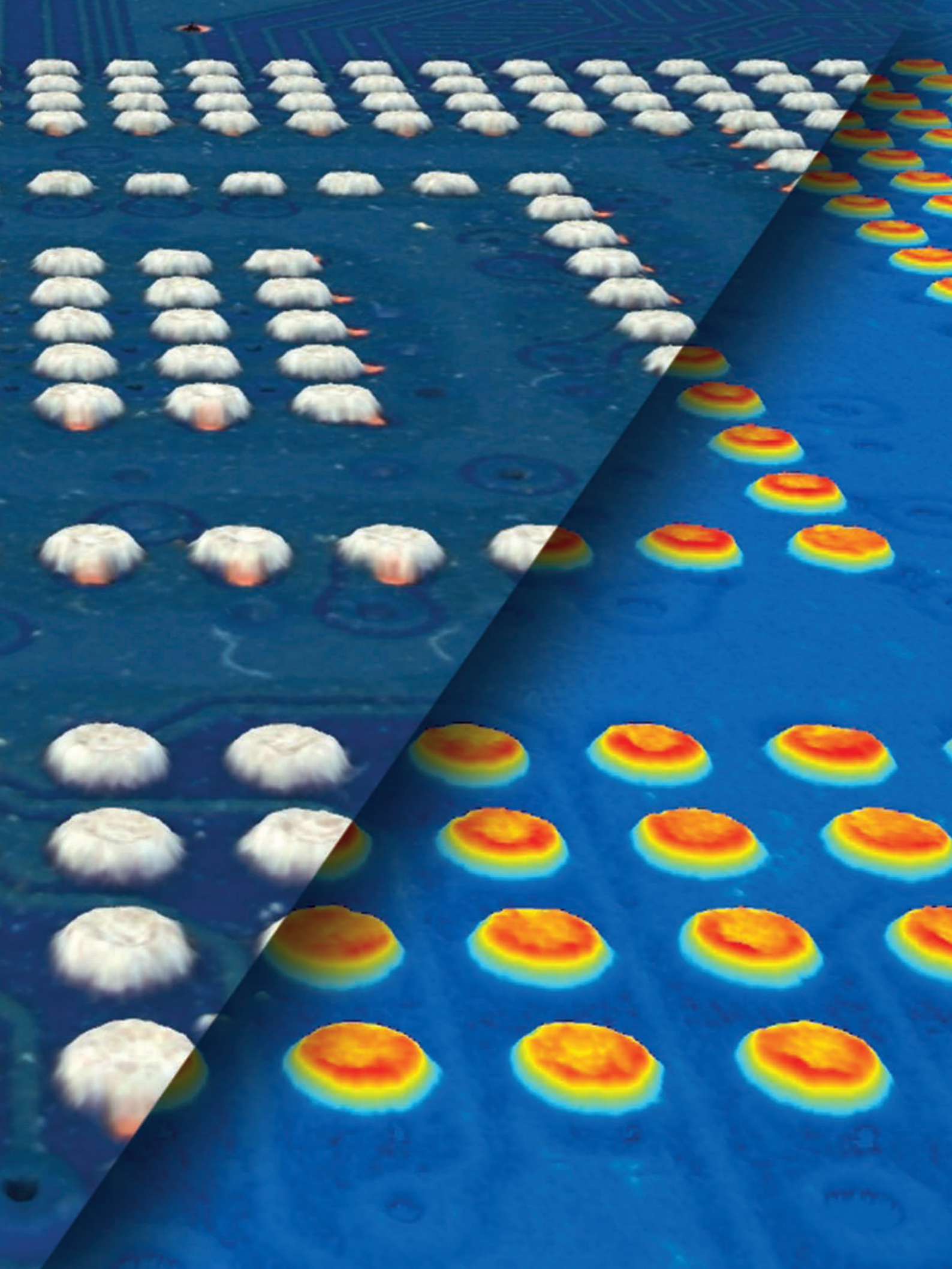



Goodbye defects. **Hello solder paste perfection.**

What are the most common defects in your SMT line? And what would you save if you could catch them earlier in your process—or even eliminate them from your design altogether?

If you're like most manufacturers, the answers to these questions will likely bring you back to the solder paste printing process. Because this is where more than 60% of all SMT defects originate, according to our latest industry survey. Whether the problem is solder shorts or insufficient solder paste deposits, accurate solder paste inspection is often the most economical way to detect, predict and prevent defects before they occur.

As solder paste deposits continue to decrease in size, the value of advanced SPI analysis will only grow over time. This is precisely what makes the innovative PI series 3D SPI system an increasingly critical part of a complete metrology solution. It allows you to measure paste volume with unmatched accuracy and unprecedented simplicity. So that you can continually improve your process and tolerance settings—and take advantage of the unambiguous real-time information you need to take your yield to new heights.

It's one more part of the Mycronic 4.0 intelligent factory, and one step closer to perfection.



PI series 3D SPI

Perfect solder joints made simple

Measure paste volume with extreme precision. Improve your process and tolerance settings with automatic pad grouping. And monitor your process in real-time, both online and offline. The PI series gives you highly accurate SPI data, combined with a range of smart auto-programming functions that ensure high-quality inspection regardless of operator experience.

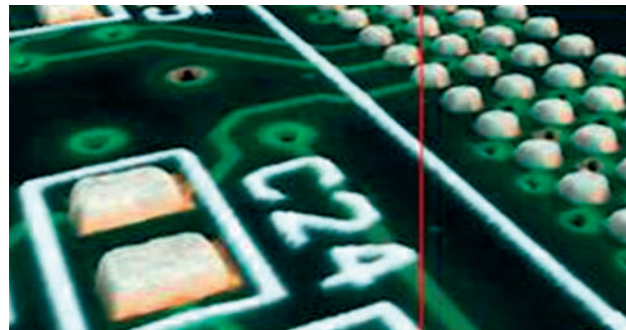

Accurate Z-referencing technology
Captures hundreds of references across an ultra-large 55 x 350mm 3D field of view.

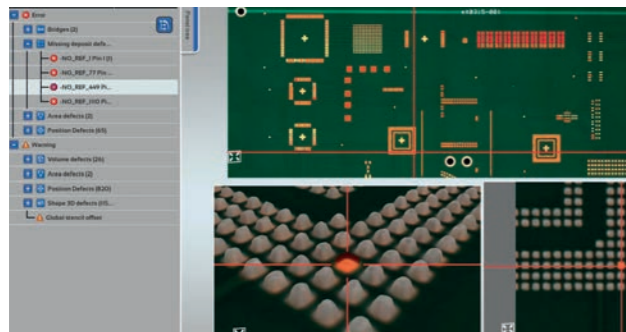

Simple auto-programming
Ensure high-quality inspection regardless of operator experience with the industry's only auto-programming SPI.



Repeatable process results
Unique warp compensation delivers accurate measurements in real production environments, with no false calls.



MY700 Jet Printer and PI series 3D SPI.

MY700 Jet Printer combined with PI series 3D SPI provides near zero-defect solder paste printing process.



INSPECTS JET-PRINTED PCB WITH THE SAME VIRTUOSITY

In line with the evolution of SMT manufacturing practices, the PI series handles jet-printed PCBs with the same inspection performances and programming process as for screen-printed boards. The synergy with Mycronic MY700 Jet Printer enables the inspection of all types of deposit shapes and volumes, regardless of the type and viscosity of the jetted paste.

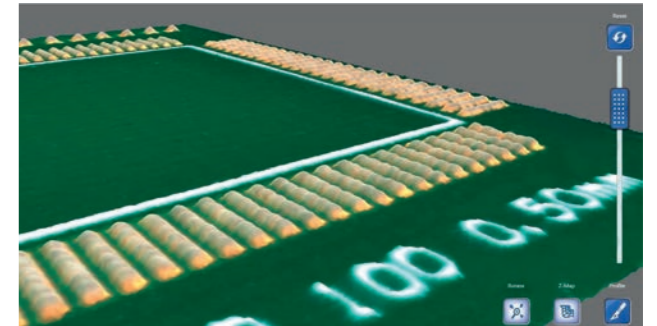

Inspection of jetted paste deposits.

Extreme inspection precision

PI series 3D SPI accurately calculates the expected volume of paste printed by the MY700 Jet Printer. Instead of evaluating this volume based on the Gerber stencil data, PI series uses data transmitted from the MY700 Jet Printer.

PI series MY700 repair loop

PI series communicates any defects resulting from insufficient paste to the MY700, along with the ID code of the concerned PCB. A second run in the jet-printer corrects the defect without having to wash and reprint the entire board.

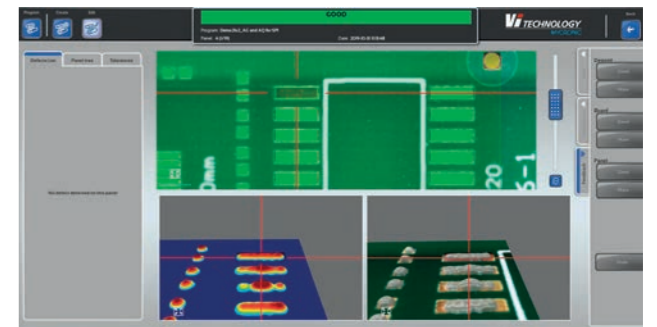

PI series 3D SPI verifying paste defect has been corrected by the MY700 Jet Printer.

Clear and simple inspection control

Thanks to a natural touchscreen interface, the PI series can easily be set up and run by anyone with just an hour's training. This intuitive design allows any operator to quickly access the system's full capabilities with no additional calibration or fine-tuning.

Intuitive touchscreen interface makes all system capabilities easy to access and navigate, with no need for keyboard or mouse inputs.

Automatic calibration is carried out with the touch of a button.

Consistent performance over time is ensured by embedded geometric and radiometric calibration tools, which also guarantee machine-to-machine portability.

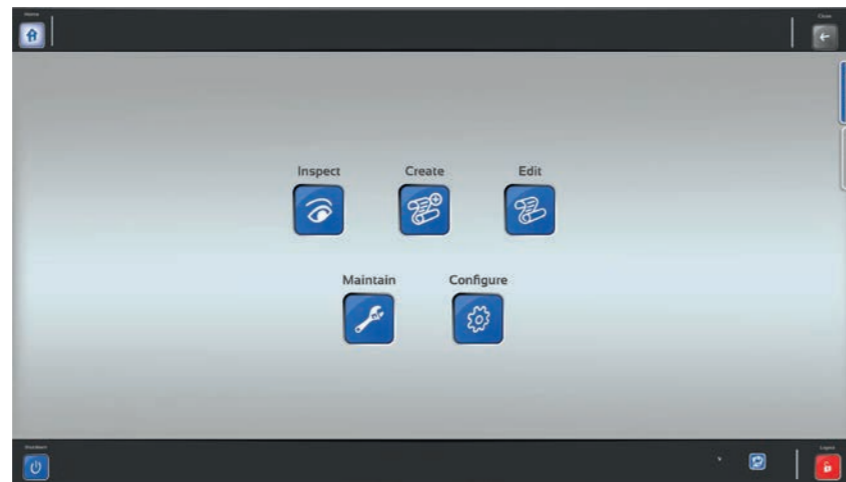

Effortless auto-programming

The industry's only auto-programming SPI system, the PI series requires only a single bare board scan to accurately program itself. No fine tuning. No manual calibration. And no unnecessary training times needed to bring programmers or operators up to speed.

Let the system program itself with just one bare board scan.

No fine tuning required due to smart auto-programming functions. Performance remains consistent regardless of color or finish variations, making the PI series ideal for new product introductions.

Simultaneous glue dot inspection capabilities, in addition to paste inspection.

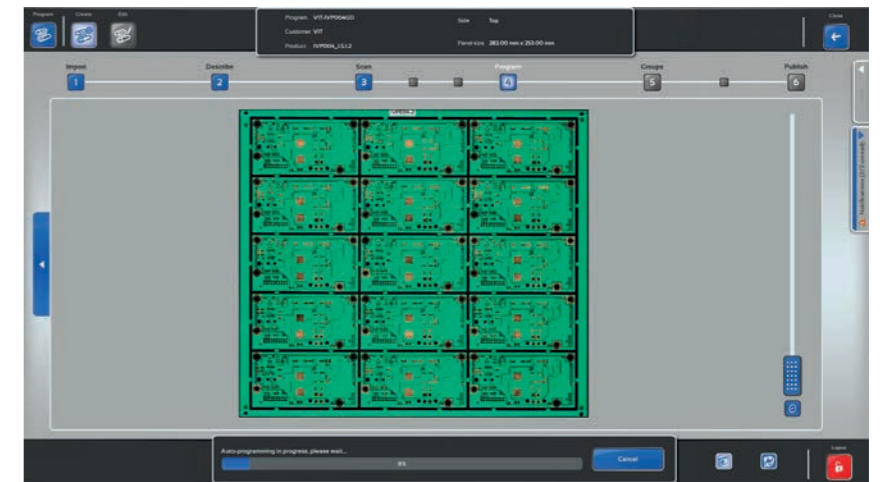

Measure paste volume with unmatched accuracy

The PI series' patented Z-referencing technology captures hundreds of references across an ultra-large 3D field of view, giving you unprecedented accuracy for even the smallest paste volume measurements.

Highly accurate paste volume measurement using a patented Z-referencing technology that overcomes the limitations of traditional SPI systems.

Superior accuracy in real production environments with no false calls due to a unique warp compensation enabled by multi-frequency, multi-pattern moiré, combined with patented dual Z-axis motion.

Unambiguous information for defect classification with high-resolution textured 3D images.

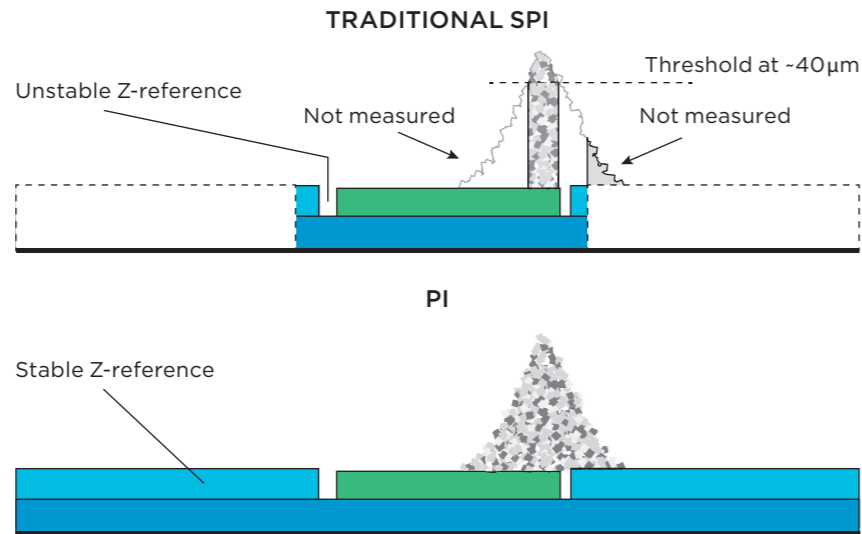

Traditional SPI: The typical threshold for a traditional SPI is usually 30–40 micrometers (μm), meaning height and volume under this limit goes unmeasured. As a result, volume is underestimated on small pads, precisely when you need to know how much paste is truly deposited.

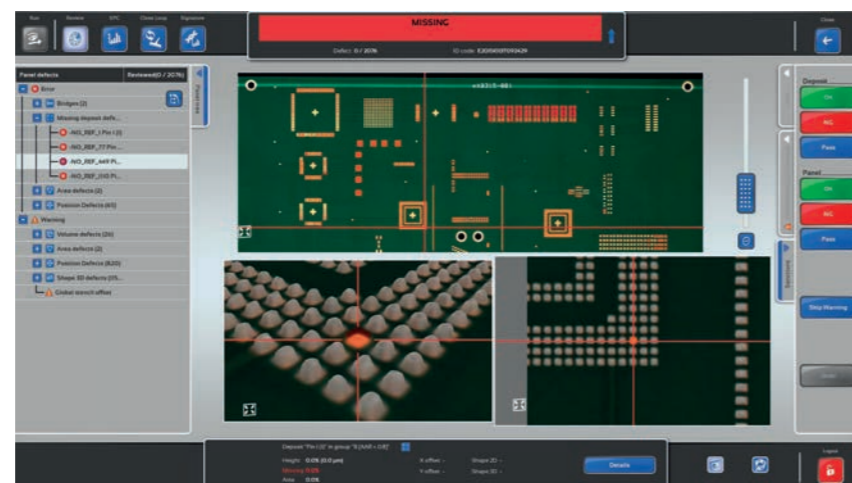

PI series: PI's patented Z-referencing method leverages the entire textured 3D board information, rather than just cropped images around the pads, to define a stable and accurate Z-reference.

Take control over your print process

PI's automatic pad grouping by AAR (Area Aperture Ratio) allows you to continuously improve your process and set tolerances independently of products. Together with the MYPro Link software suite, this means you can transform your inspection data into actionable process information.

Improve your process and set tolerances independently of products with meaningful automatic pad grouping by AAR.

Gain new insights into your process with extra-large review images in textured 3D for easy diagnostics.

Monitor your process in real time with MYPro Analyze, which helps you report and monitor your progress with useful trend analyses.

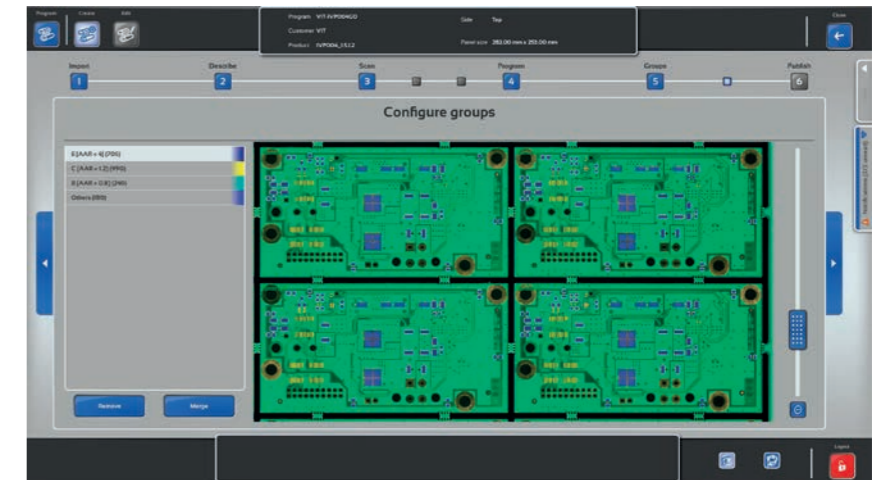

PI series 3D SPI

State-of-the-art design

Robust conception, smart access and built-in manual for fast and easy maintenance, every aspect has been designed to simplify your operations.

INSPECTION TECHNOLOGY	PI PICO	PI PRIMO
3D engine	360° Moiré—Shadow free, Multi-camera, Multi-projector, Multi-pattern	
Camera	80Mpixel, 12-bit CMOS sensor	160Mpixel, 12-bit CMOS sensor
Projection	4 HD, 10-bit industrial projectors	8 HD, 10-bit industrial projectors
Field of View (X x Y)	160mm x 55mm	350mm x 55mm
Lighting	White LED + RGB lighting	
Warp compensation	±5mm with dual Z-axis motion for real-time Z and Q adjustments	
Z-reference	Full PCB inspection for Z-referencing with no cropping around pad	

INSPECTION PERFORMANCE	PI PICO/PI PRIMO
Measurements	Height, Area, Volume, Offset, Bridging, Shape 2D, Shape 3D, Coplanarity
Defect types	Insufficient/Excessive/Missing paste, Bridge, Shape 2D, Shape 3D, User defined defect, Paste pollution
Minimum paste/glue deposit size	100µm x 100µm
Maximum paste/glue deposit size	20mm x 20mm
Maximum paste height	400µm (consult for higher paste height)
Height resolution	100nm
Height accuracy	<2µm on Certification target at operating temperature
Height repeatability	<1µm at 3σ on Certification target at operating temperature
Volume repeatability	<3% at 3σ on PCB at operating temperature
Inspection speed	3 sec. per Field of View

SOFTWARE SUITE	PI PICO/PI PRIMO
Offline programming software	MYPro Create (Gerber, CAD data, glue deposit data)
Online SPC	Alerts in case of process drift

SYSTEM	PI PICO/PI PRIMO
Operating system	Linux
Storage capacity	6TB including 4TB in RAID 1
Axis motion	Stepper motor and linear optical encoder (1µm resolution)

OPTIONS	PI PICO/PI PRIMO
External barcode readers (1D/2D)	Cognex DM 150 or Keyence SR1000
Internal barcode readers (1D/2D)	Software option enabling reading from inspection head
Uninterruptible power supply	For PC/230V
Closed loop with stencil printer	Available for all major stencil printer brands
Glue deposit inspection	Simultaneous inspection for paste and glue
M2M conveying mode	Kit to implement IPC HERMES 9852 protocol
Other options available	Please contact us

FACILITIES	PI PICO/PI PRIMO
Interface	IPC-SMEMA-9851
Power requirements	Single Phase 2P + Earth, AC 100–240V/16A, no need for compressed air
Dimensions in mm (W x D x H)	1,000 (800 optional) x 1,296 x 1,932 (adjustable height)
Weight	430kg
Operating temperature	15–30°C
Relative humidity	20–75% (without condensing)

PCB HANDLING	PI PICO		PI PRIMO			
	S	M	S	M	L	XL
Minimum PCB dimensions	51mm x 51mm (2 x 2")					
Maximum PCB dimensions (X x Y)	350 x 533 mm (14 x 21")	533 x 533 mm (21 x 21")	350 x 533 mm (14 x 21")	533 x 533 mm (21 x 21")	609 x 533 mm (24 x 21")	762 x 533 mm (30 x 21")
Minimum PCB thickness	0.1mm					
Maximum PCB thickness	5mm					7.5mm
Minimum edge clearance	3mm					
Top clearance	20mm					
Bottom clearance	50mm					
Conveying direction	Left to right/Right to left/Left to left/Right to right					
Conveyor width adjustment	Automatic					
Conveying height	830–930mm (standard)/900–1,000mm (optional)					
Conveyor length	1,000mm (standard) 800mm (optional)	1,000mm	1,000mm (standard) 800mm (optional)	1,000mm	1,250mm	1,250mm
Maximum PCB weight	4kg					4.5kg

DIMENSIONS PI PICO/PI PRIMO [mm]

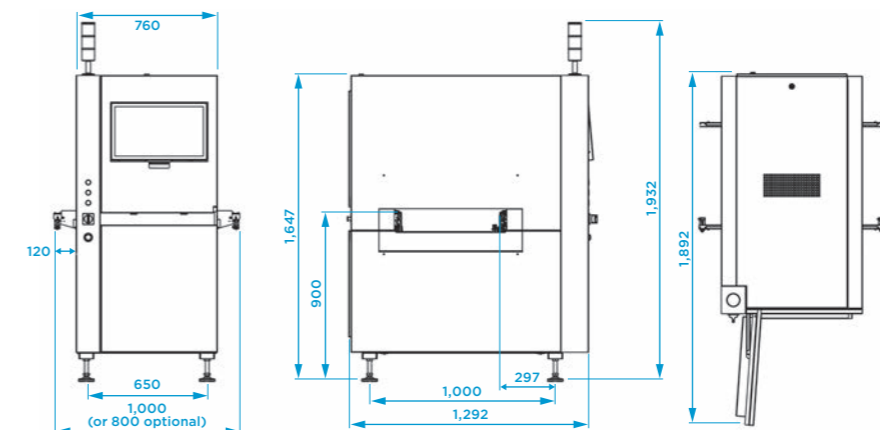

Bringing tomorrow's electronics to life

MYCRONIC

MYCRONIC.COM

SWEDEN

Mycronic AB
PO Box 3141
Nytorpsvägen 9
SE-183 03 Täby
Sweden

Tel: +46 8 638 52 00

NETHERLANDS

Mycronic B.V.
High Tech Campus 10
5656 AE
Eindhoven
Netherlands

Tel: +31 402 62 06 67

FRANCE

Mycronic S.A.S.
1 rue de Traversière
CS 80045
94513 Rungis Cedex 1
France

Tel: +33 1 41 80 15 80

SOUTH KOREA

Mycronic Co. Ltd.
3rd Floor, Jung-San Bldg.
163 LS-ro Gunpo-Si
Gyeonggi-Do, 15808
South Korea

Tel: +82 31 387 5111

SINGAPORE

Mycronic Pte., Ltd.
9 Tagore Lane,
#02-08/09
9@Tagore
Singapore 787472

Tel: +65 6281 7997

GERMANY

Mycronic GmbH
Biberger Straße 93
D-82008 Unterhaching
bei München
Germany

Tel: +49 89 4524248-0

UK

Mycronic Ltd.
Unit 2, Concept Park
Innovation Close
Poole, Dorset, BH12 4QT
UK

Tel: +44 1202 723 585

CHINA

Mycronic Co., Ltd.
Unit 106, E Block
Lane 168, Da Duhe Road.
Putuo District, 200062
Shanghai P.R. China

Tel: +86 21 3252 3785/86

JAPAN

Mycronic Technologies KK
KDX Chofu Bldg.7th floor
1-18-1 Chofugaoka,
Chofu-shi
Tokyo 182-0021
Japan

Tel: +81 42 433 9400

USA

Mycronic Inc.
554 Clark Road
Tewksbury
MA 01C876-1731
USA

Tel: +1 978 495 9799